

Hubble Space Telescope Paper Model

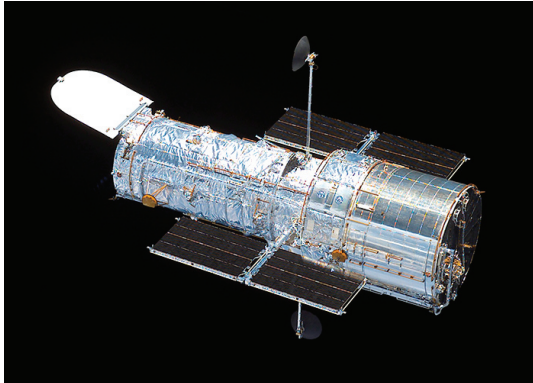

Pattern Pieces: Print this document on cover-weight paper or cardstock.

Downloads, instructions, and other information at: www.hubblesite.org/go/model



The real Hubble Space Telescope

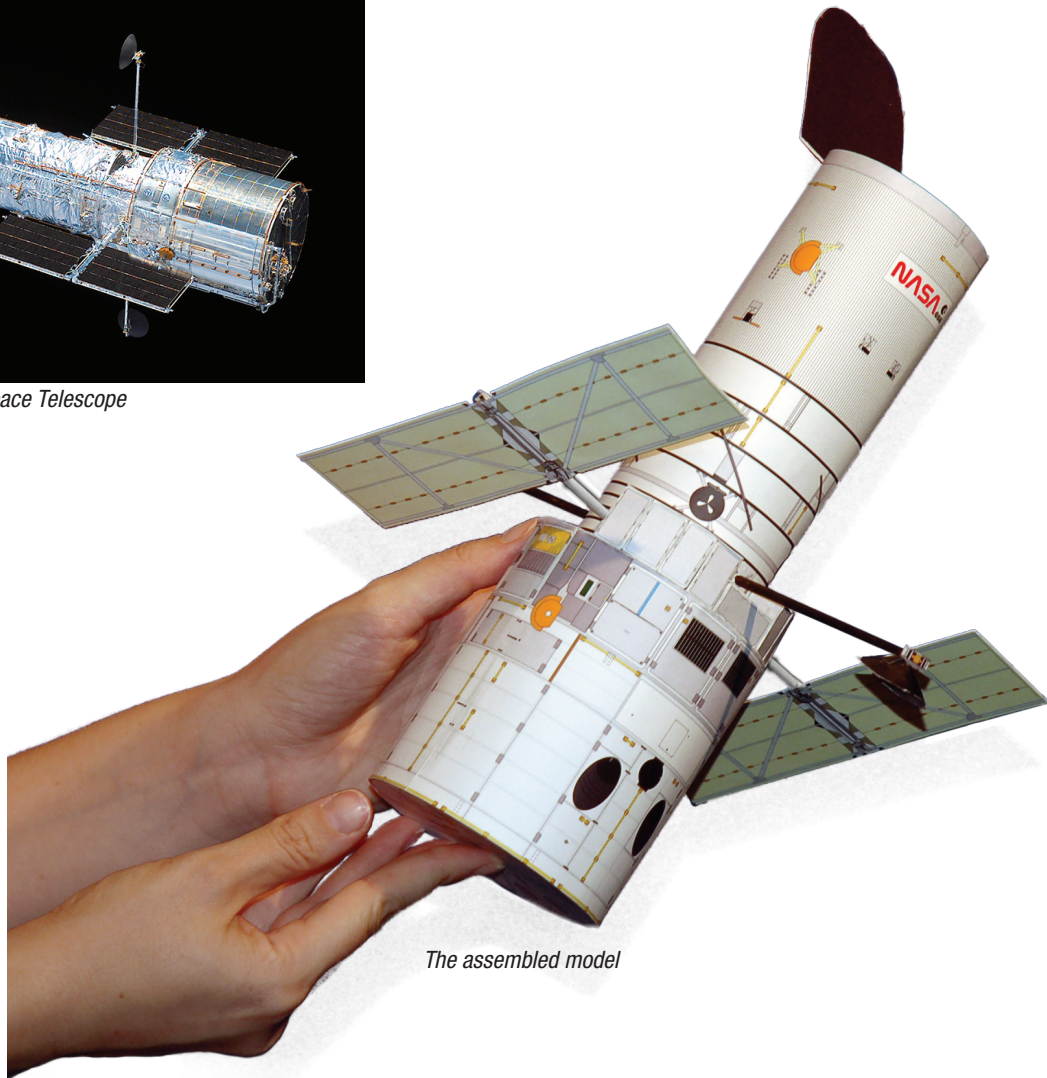

The assembled model

Based on a design by
Ton Noteboom

Distributed with permission by
Space Telescope
Science Institute

www.hubblesite.org



Hubble Space Telescope

This model is based on the configuration after Servicing Mission 3B, conducted by the crew of STS-109 in March, 2002



Construction tips:

When assembling your model, keep track of which pieces are which by only cutting out the pieces you need for the particular part you are assembling, and lightly writing the number of the piece in pencil on the back.

Print this pattern onto white cardstock; it looks best in color. You may want to have extra printouts handy in case you need them.

The directions (in a separate file) can be printed on regular paper in black-and-white.

Pattern key:

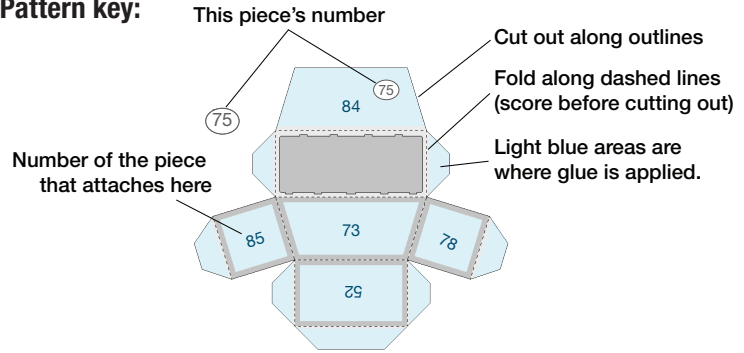

Pattern scale:

This model is designed to be at 1:48 scale relative to the real Hubble Space Telescope.

To ensure your model hasn't been resized during printing, measure this scale.

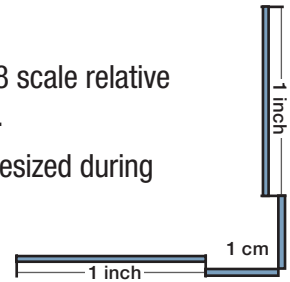

The Hubble Space Telescope

View from front

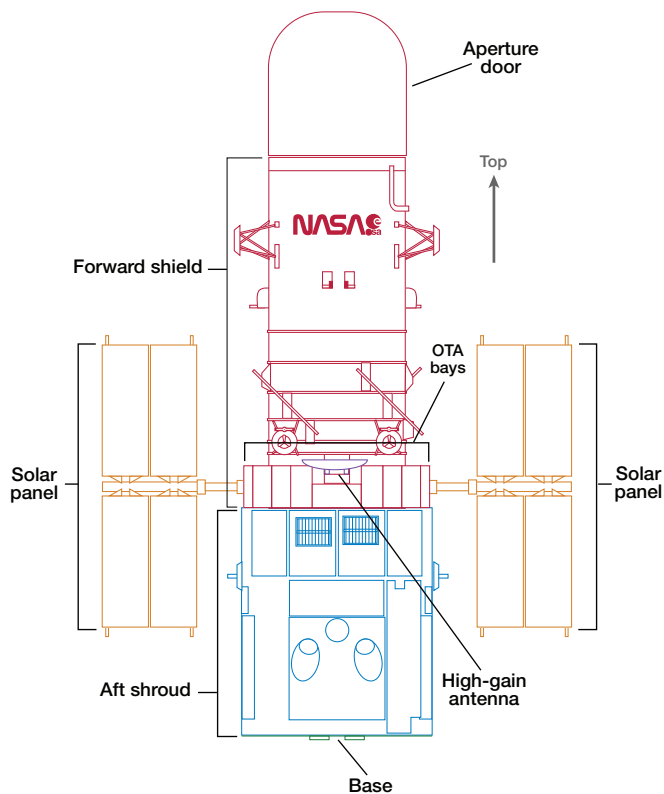

View from side

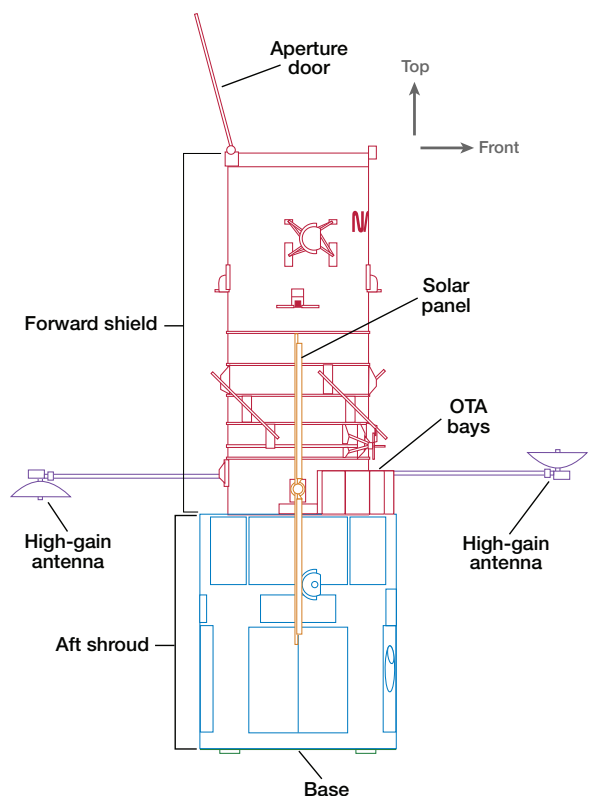

Aft shroud

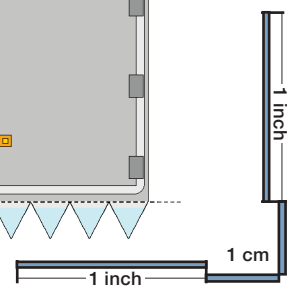
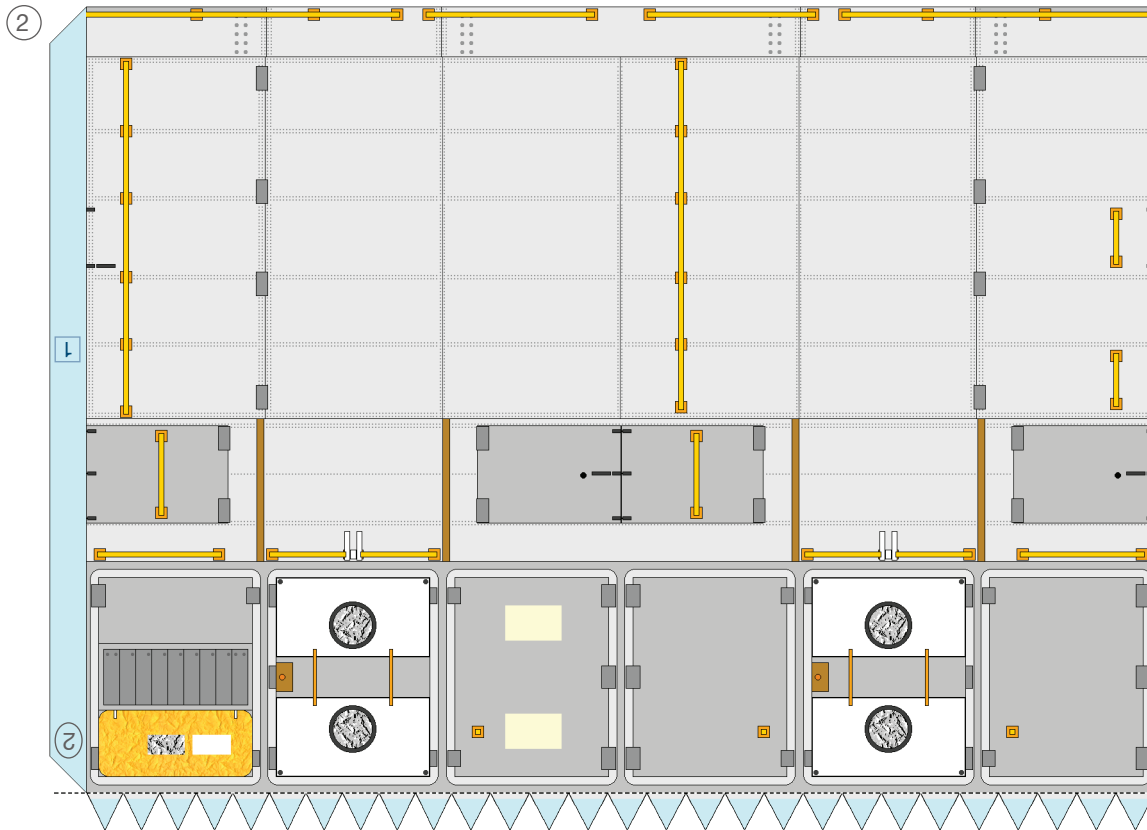
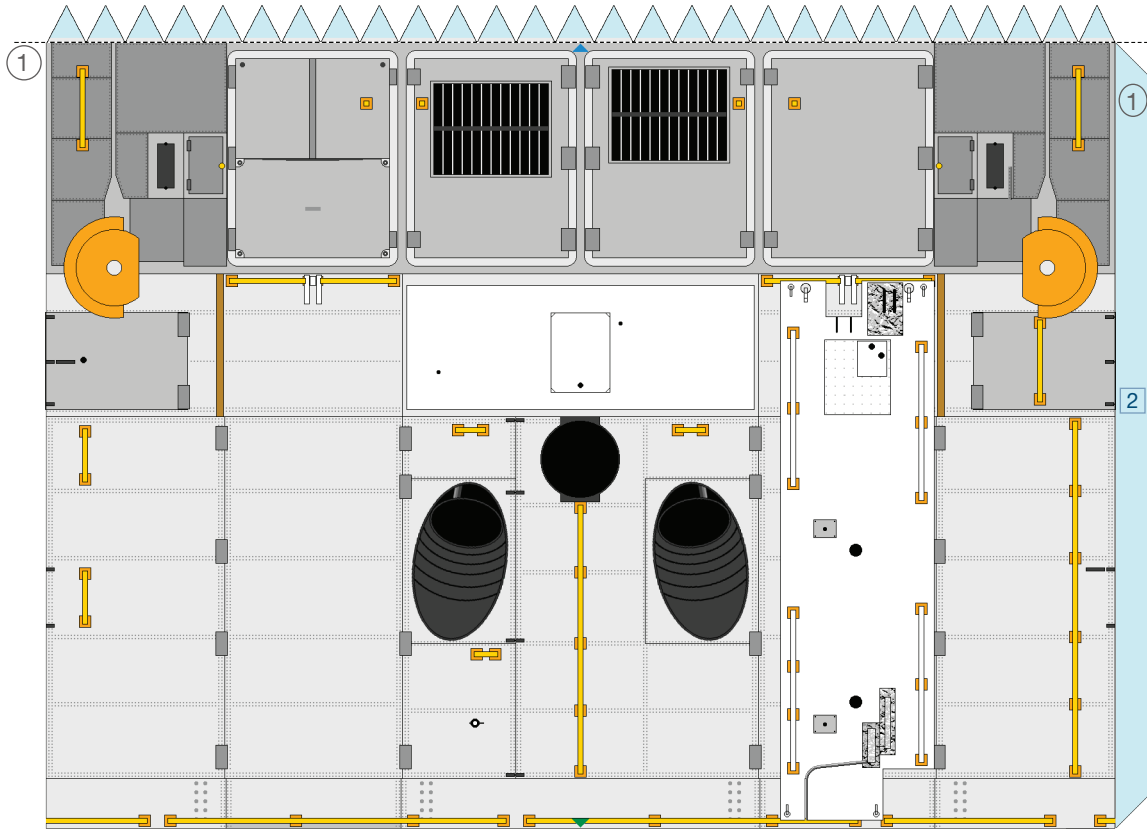

Aft shroud

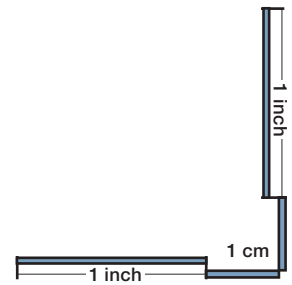
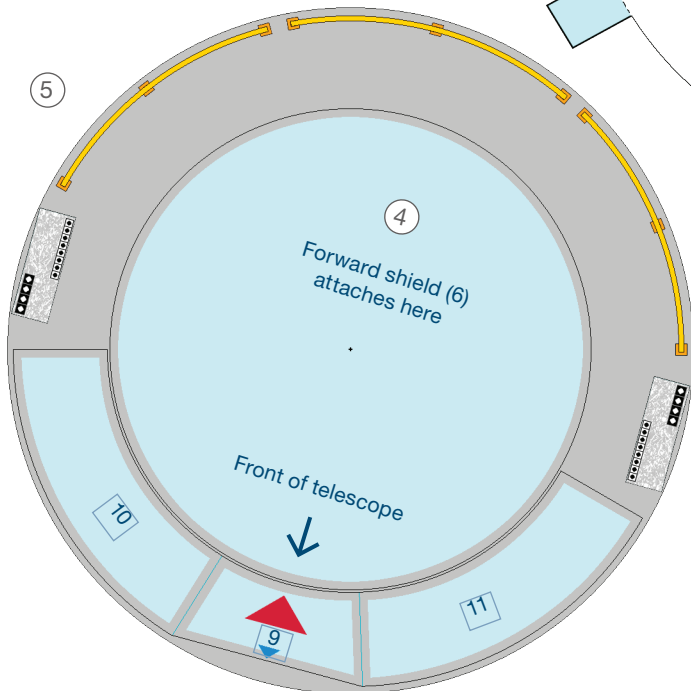
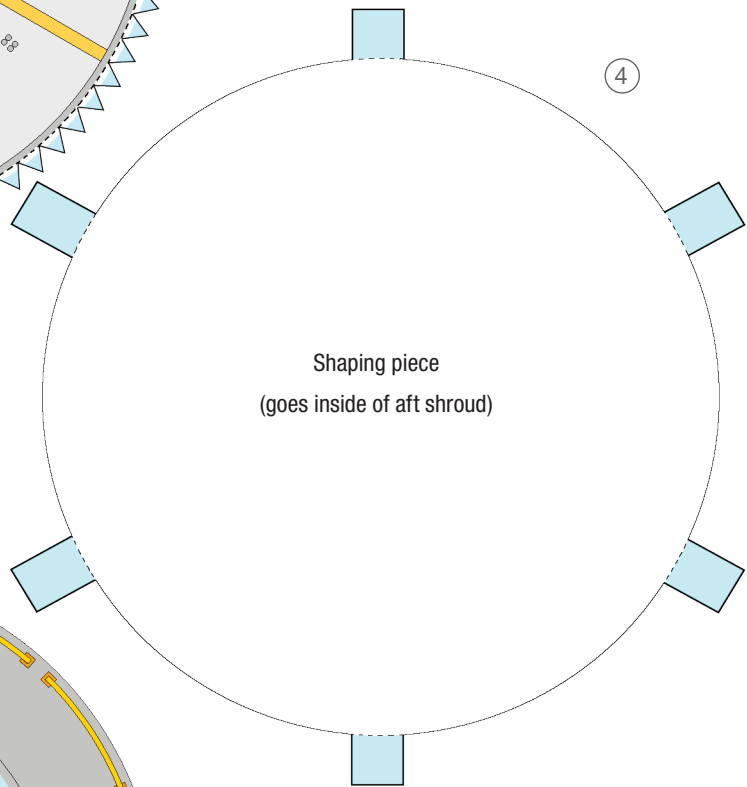
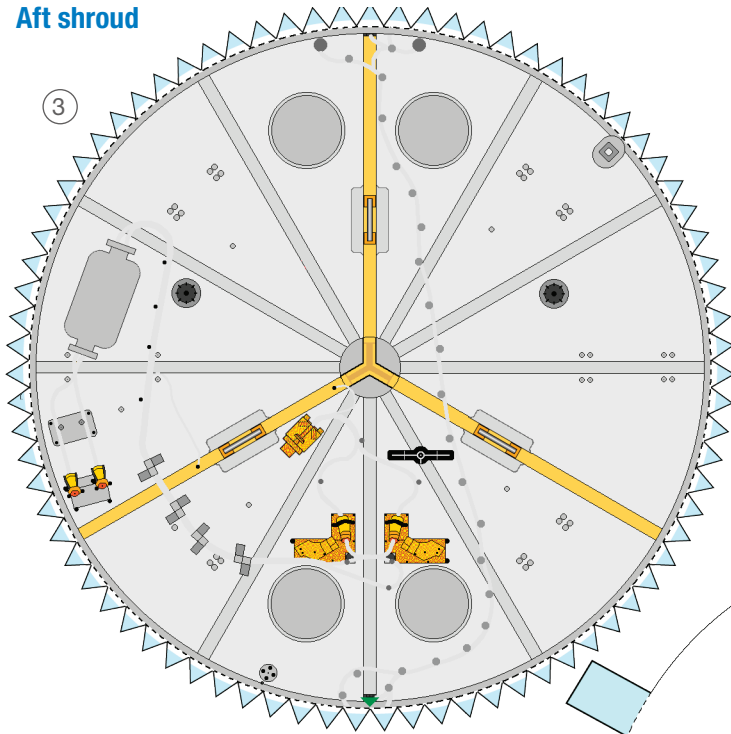

Cut out all four squares that look like: 

Forward Shield

⑥

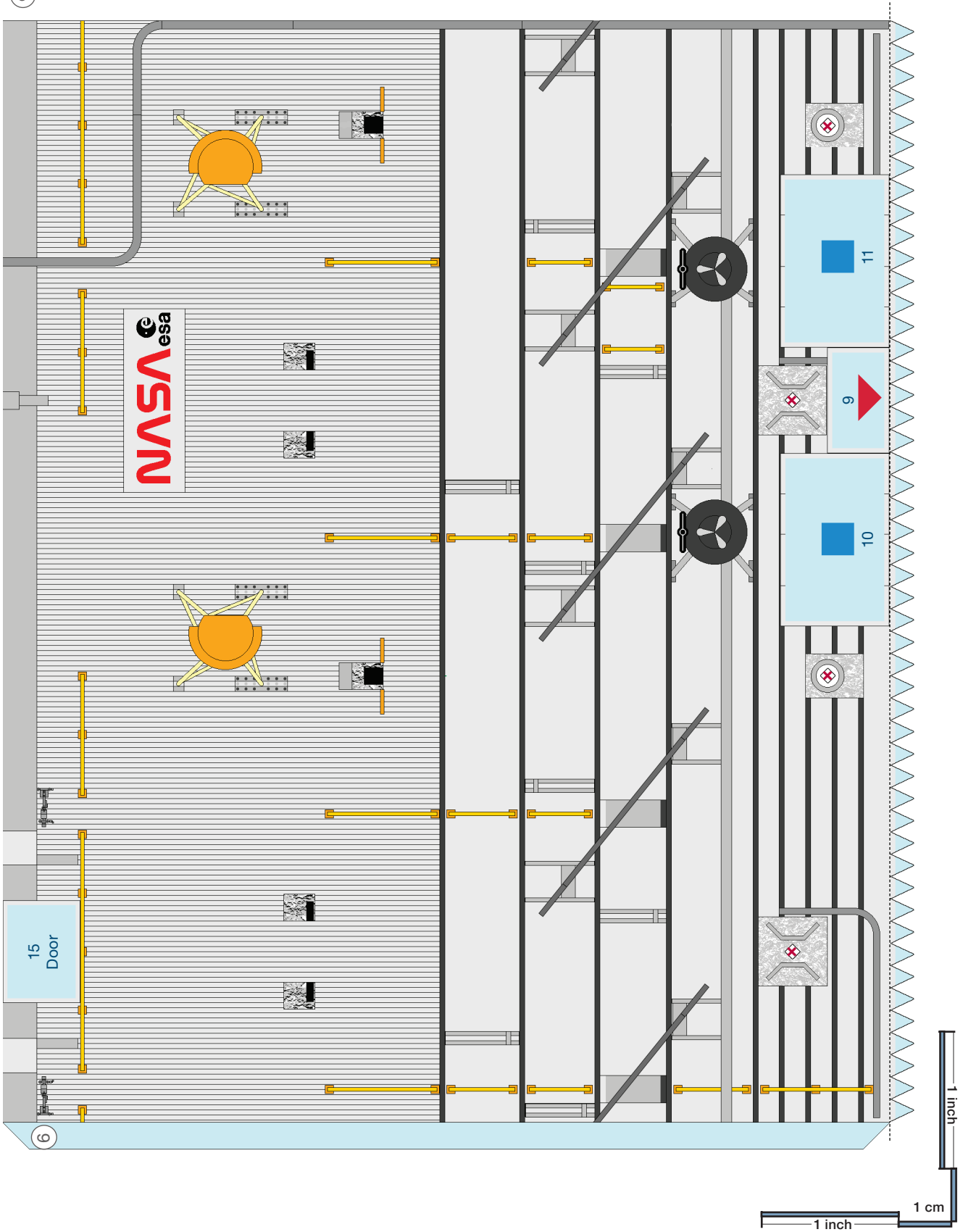

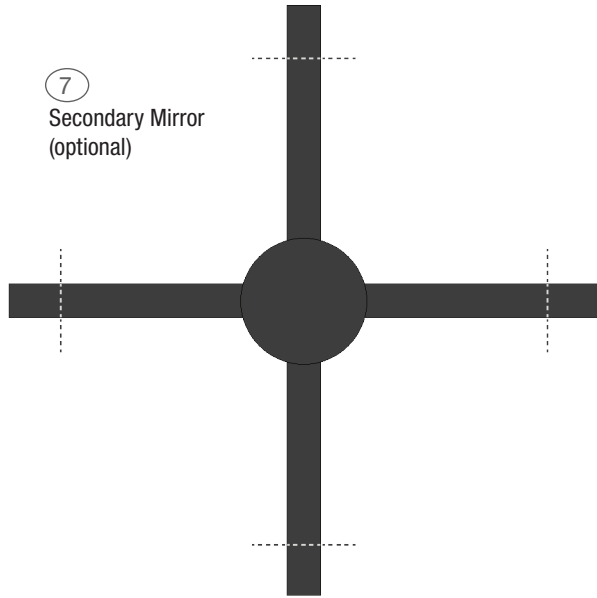

Primary Mirror
(glue foil to surface)

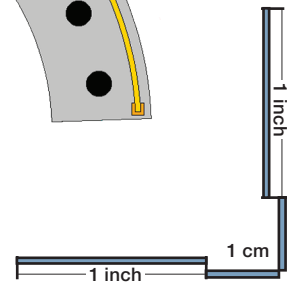
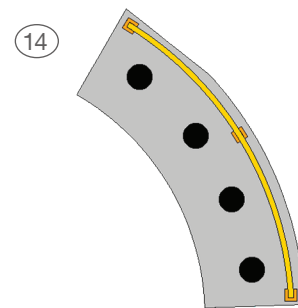
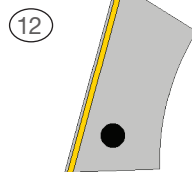
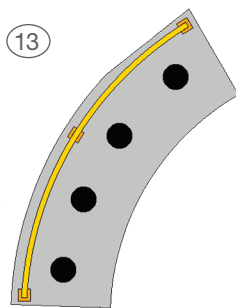
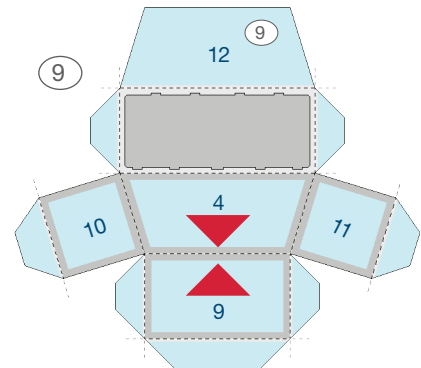
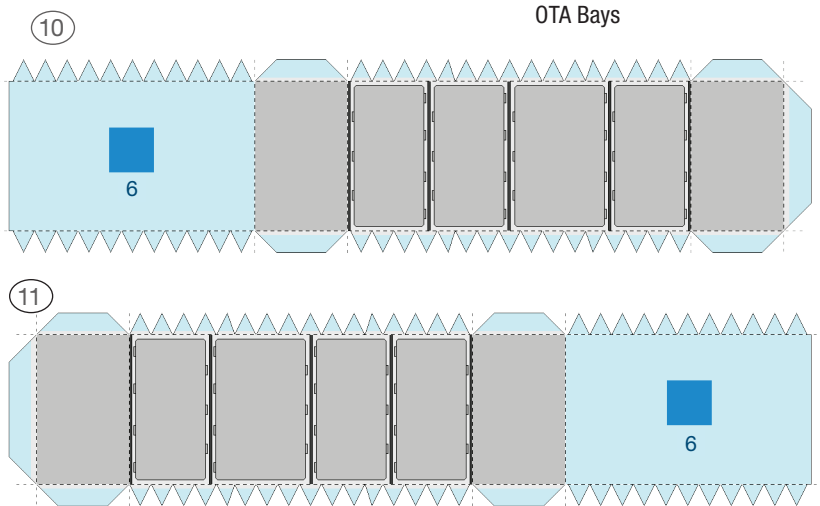
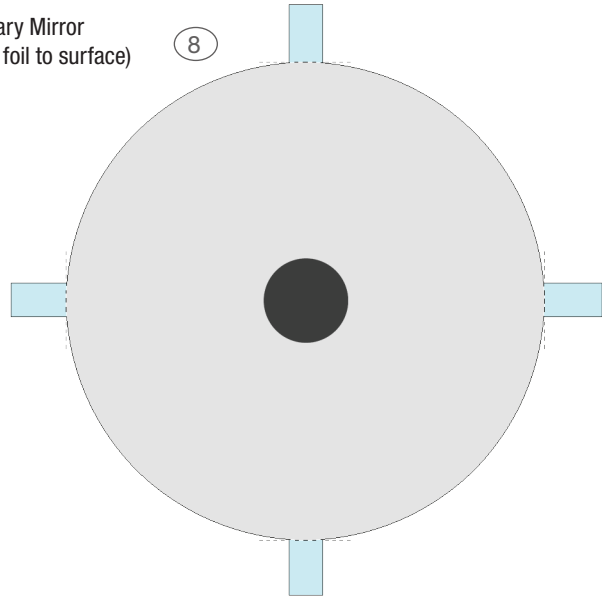

High-gain antenna

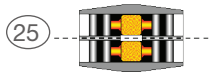
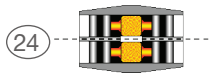
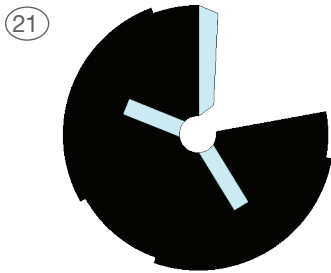
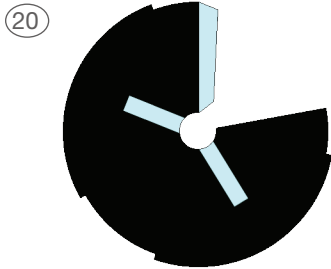

15 Aperture door

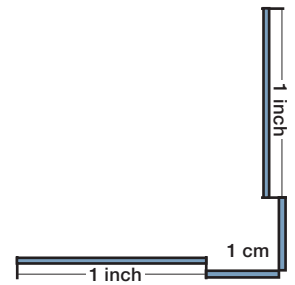
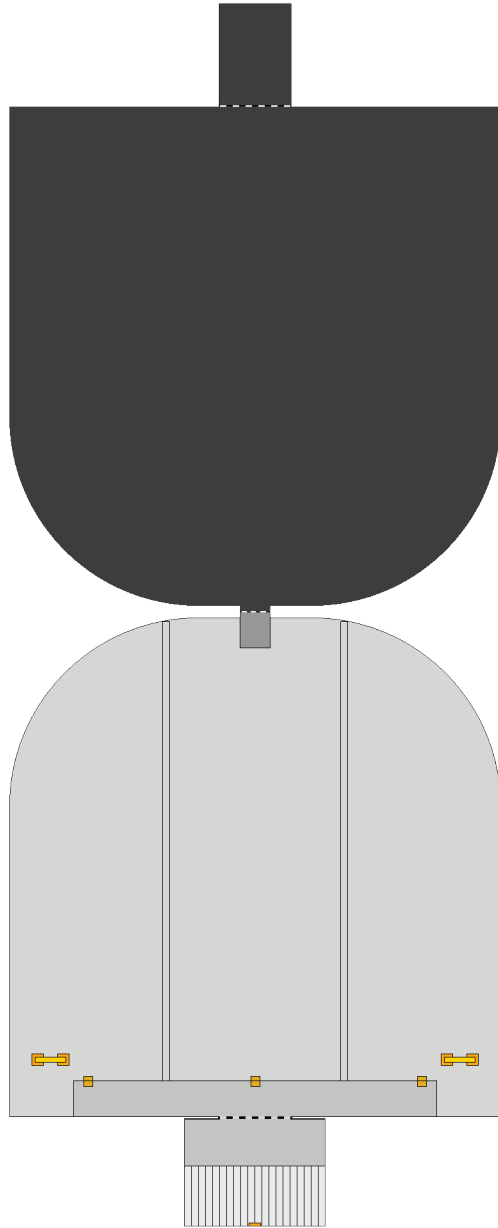

Solar Panels

dowel guide — dowels should be this length.

